

Interrupteurs bipolaires

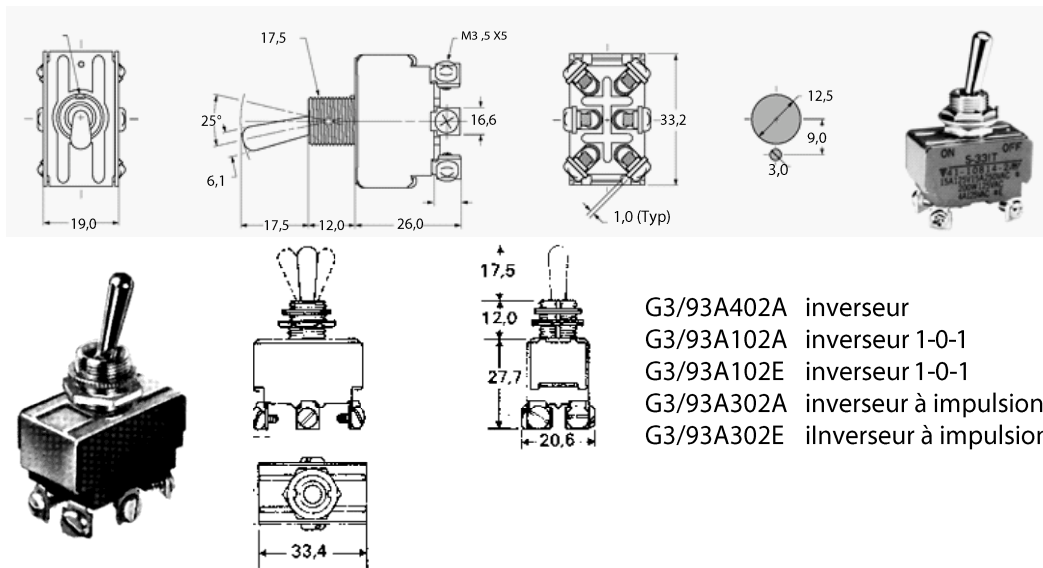

- G3/93A402A inverseur
- G3/93A102A inverseur 1-0-1
- G3/93A102E inverseur 1-0-1
- G3/93A302A inverseur à impulsion 1-0-1
- G3/93A302E inverseur à impulsion 1-0-1

A = connexions à visser
E = connexions enfichables

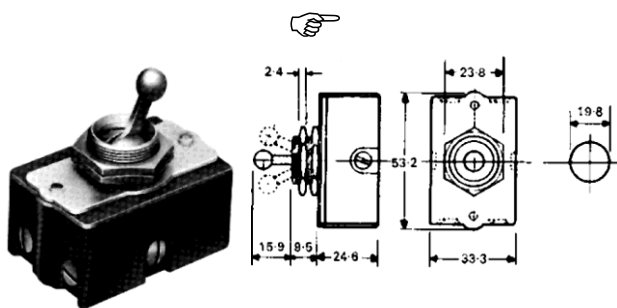

G3/80638-D inverseur avec blocage de commutation au point zéro
5A/250V



G5/A.202/R interrupteur avec vis de mise à terre
10(6)A/380V

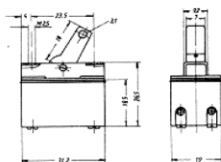

G1/0045.5305 Levier avec alésage de 3,1 mm
4(4)A/250V

approprié pour METABO

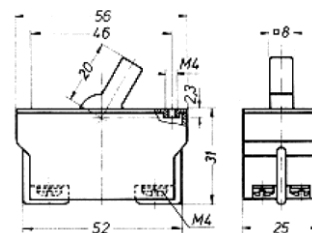
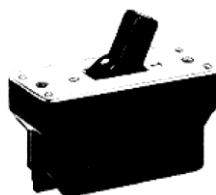

G1/0320.0302 avec levier de 27 mm de longueur
16(6)A/250V



Livable jusqu'à épuisement du stock!

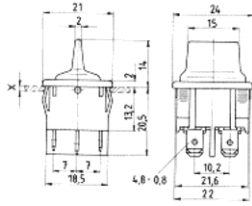
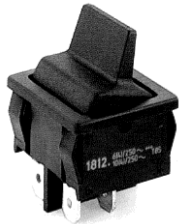

G1/1812.1102 interrupteur 10(4)A/250V
 G1/1819.1102 inverseur 1-0-1
 G1/1819.1302 inverseur à impulsion 1-0-1
 6(2)A/250V

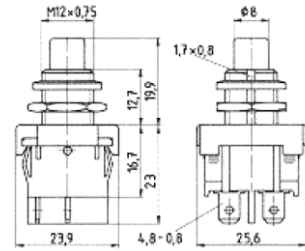

G1/1842.1101 interrupteur
 G1/1844.1101 inverseur
 6(4)A/250V

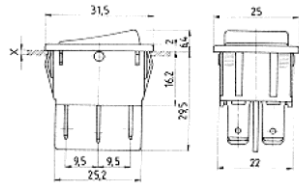

G1/1832.3311 interrupteur blanc
 G1/1832.3312 interrupteur noir
 16(4)A/250V

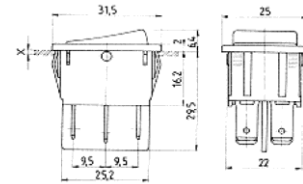

G1/1834.3311 inverseur blanc
 G1/1834.3312 inverseur noir
 16(4)A/250V

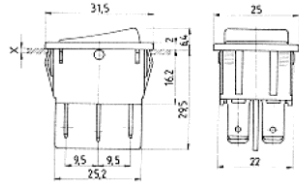

G1/1839.1507 inverseur 1-0-1, noir
 6(4)A/250V

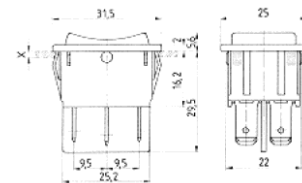

G1/1839.3402 inverseur à impulsion 1-0-1
 6(4)A/250V

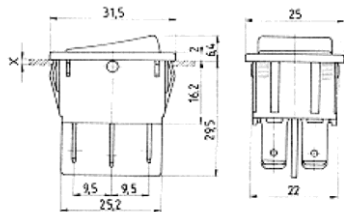

G1/1835.3111 boîtier blanc, bascule rouge lumineux
 G1/1835.3117 boîtier blanc, bascule verte lumineux
 G1/1835.3112 boîtier noir, bascule rouge lumineux
 G1/1835.3114 boîtier noir, bascule orange lumineux
 G1/1835.3118 boîtier noir, bascule verte lumineux
 16(4)A/250V



G1/1837.8102 lampe témoin: boîtier noir/rouge lumineux
 G1/1837.8108 lampe témoin: boîtier noir/vert lumineux
 230V T100

Livrable jusqu'à épuisement du stock!

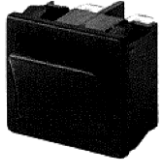
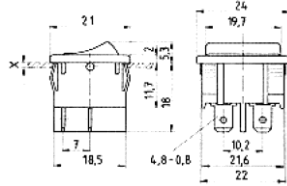
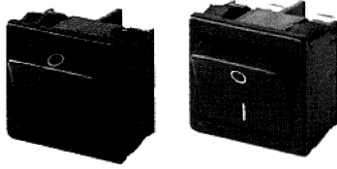

G1/1802.1102 interrupteur
 G1/1802.1108 dito avec 0-1
 G1/1804.1102 inverseur
 G1/1809.1302 inverseur à impulsion 1-0-1
 16(4A)/250V

G1/1805.7110 boîtier noir, bascule rouge
 lumineux

G1/1805.7104 boîtier noir, bascule orange
 lumineux

G1/1805.7109 boîtier noir, bascule verte
 lumineux
 16(4)A/250V

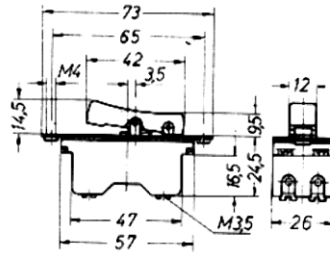
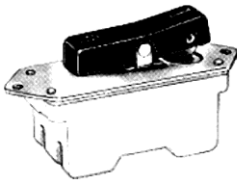

G1/1251.0101 interrupteur
 10(10)A/250V
 capuchon de protection en caoutchouc
 voyez page I12.

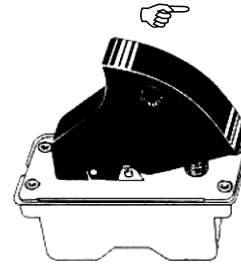

G5/A.423N0 contact de fermeture
 15(10)A/250V
 utilisable à la place de
 Marquardt 1263.0801

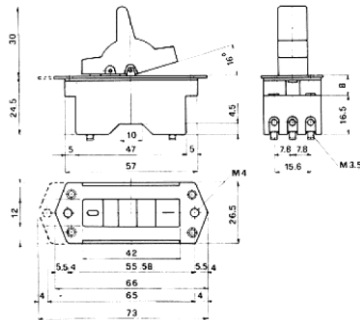
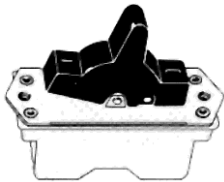

G5/A.431N1 interrupteur 15(10)A/250V
 distance entre les trous 55 mm



Livable jusqu'à épuisement du stock!

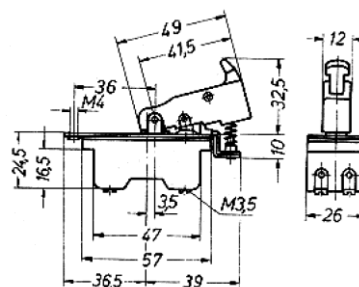
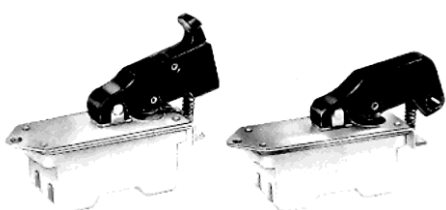
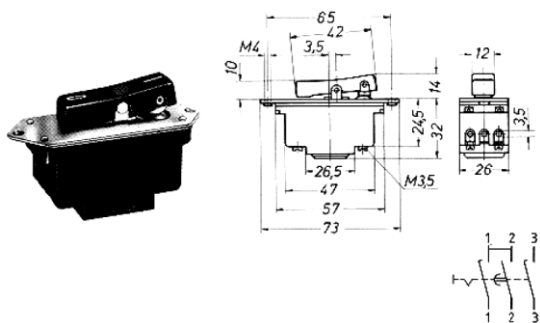

G1/1263.0101 contact de fermeture avec verrouillage
 G1/1263.0201 contact de fermeture sans verrouillage

10(10)A/250V



G5/A.202/MAL contact de fermeture
 approprié pour les meuleuses METABO et les scies circulaires FESTO

 **Livable jusqu'à épuisement du stock!**

